

# Instructions for installation and use

WASHER DRYER

EN

English, 1

**AQUALTIS**

**AQM8L 29 I**

## Contents

### Installation, 2-3-4-5

Unpacking and levelling  
Connecting the electricity and water supplies  
Technical data

### Description of the machine, 6-7

Control panel

### How to run a wash cycle or a drying cycle, 8-9

### Wash cycles and options, 10

Table of wash cycles  
Wash options

### Detergents and laundry, 11

Detergent  
Preparing the laundry  
Washing recommendations  
Load balancing system

### Precautions and advice, 12

General safety  
Disposal  
Opening the porthole door manually

### Care and maintenance, 13

Cutting off the water and electricity supplies  
Cleaning the machine  
Cleaning the detergent dispenser drawer  
Caring for your appliance drum  
Cleaning the pump  
Checking the water inlet hose

### Trouble shooting, 14

### Assistance, 15

EN

# Installation

EN

! This instruction manual should be kept in a safe place for future reference. If the washer dryer is sold, given away or moved, please ensure the manual is kept with the machine, so that the new owner may benefit from the advice contained within it.

! Read these instructions carefully: they contain vital information relating to the safe installation and operation of the appliance.

! Inside the pack containing this manual, you will also find the guarantee and all the details necessary for installation.

## Unpacking and levelling

### Unpacking

1. Once you have removed all the packaging from the washer dryer, make sure it has not been damaged during transportation.

If it has been damaged, contact the retailer and do not proceed any further with the installation process.

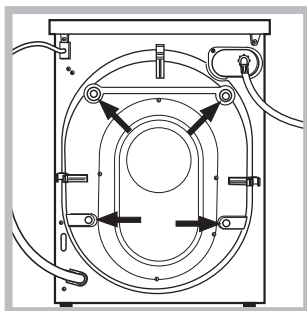

2. Remove the 4 protective screws (used during transportation) and the corresponding spacer, located on the rear part of the appliance (see figure).

3. Close off the holes using the plastic plugs supplied in the pack.

4. Keep all the parts in a safe place; they will be needed again if the washer dryer is moved to another location, to prevent the inside of the appliance being damaged.

! Packaging materials should not be used as toys for children.

### Levelling

1. Place the washer dryer on a flat sturdy floor, without resting it up against walls or cabinets.

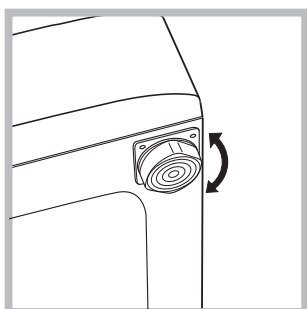

2. If the floor is uneven, the front feet of the machine may be adjusted until it reaches a horizontal position (the angle of inclination must not exceed 2 degrees).

! If the appliance is levelled correctly, it will be more stable and much less likely to cause vibrations and noise while it is operating, particularly during the spin cycle.

! If it is placed on carpet or a rug, adjust the feet in such a way as to allow a sufficient ventilation space underneath the washer dryer.

## Connecting the electricity and water supplies

### Connecting the water inlet hose

! Before connecting the inlet hose to the water supply, run the water until it is perfectly clear.

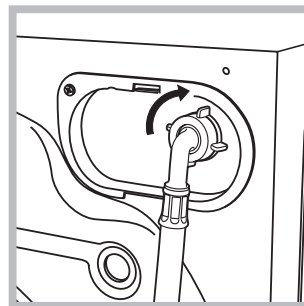

1. Connect the inlet hose to the machine by screwing it onto the cold water inlet of the appliance, which is situated on the top right-hand side of the rear part of the appliance (see figure).

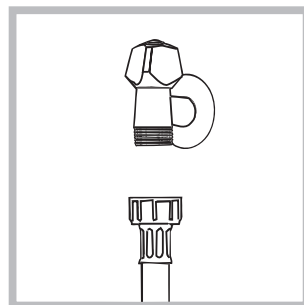

2. Connect the inlet hose by screwing it to a cold water tap using a 3/4 gas threaded connection (see figure).

3. Make sure that the hose is not folded over or bent.

! The water pressure at the tap must fall within the values indicated in the Technical data table (see next page).

! If the inlet hose is not long enough, contact a specialised shop or an authorised technician.

! Never use second-hand or old inlet hoses; use the products supplied with the machine.

### Connecting the drain hose

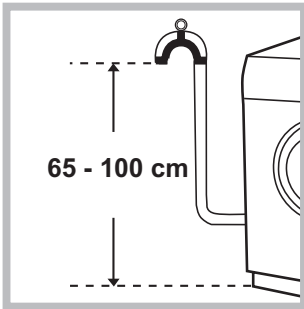

Connect the drain hose, without bending it, to a draining duct or a wall drain situated between 65 and 100 cm from the floor;

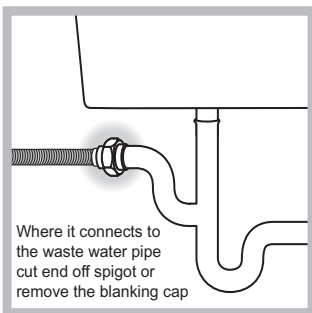

The drain hose may be connected to an under-sink trap. Before connecting the drain hose from the machine ensure that any blanks or removable ends have been taken off the spigot.

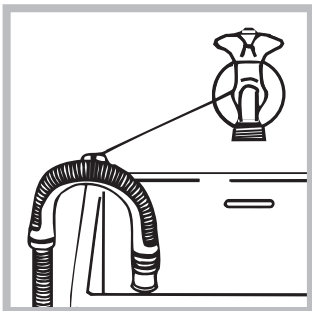

If it is place over the edge of a basin or sink be sure the free end of the hose should not be underwater.

**!** We advise against the use of hose extensions; in case of absolute need, the extension must have the same diameter as the original hose and must not exceed 150 cm in length.

Ensure that if the drain hose is pushed into a standpipe, that the end does not go down more than 15cms (6 inches). If the hose is pushed down too far, this may cause the machine to self-siphon ie. continuously empty as it is filling.

### Electric connection

Before plugging the appliance into the mains socket, make sure that:

- the socket is earthed and in compliance with the applicable law;
- the socket is able to sustain the appliance's maximum power load indicated in the Technical details table (see page 5);

- the supply voltage is included within the values indicated on the Technical details table (see page 5);

- the socket is compatible with the washing machine's plug. If this is not the case, replace the socket or the plug.

Your appliance is now supplied with a 13 amp fused plug it can be plugged into a 13 amp socket for immediate use. Before using the appliance please read the instructions below.

**WARNING - THIS APPLIANCE MUST BE EARTHED. THE FOLLOWING OPERATIONS SHOULD BE CARRIED OUT BY A QUALIFIED ELECTRICIAN.**

#### Replacing the fuse:

When replacing a faulty fuse, a 13 amp ASTA approved fuse to BS 1362 should always be used, and the fuse cover re-fitted. If the fuse cover is lost, the plug must not be used until a replacement is obtained.

#### Replacement fuse covers:

If a replacement fuse cover is fitted, it must be of the correct colour as indicated by the coloured marking or the colour that is embossed in words on the base of the plug. Replacements can be obtained directly from your nearest Service Depot.

#### Removing the plug:

If your appliance has a non-rewireable moulded plug and you should wish to re-route the mains cable through partitions, units etc., please ensure that either: the plug is replaced by a fused 13 ampere re-wearable plug bearing the BSI mark of approval.

or:

the mains cable is wired directly into a 13 amp cable outlet, controlled by a switch, (in compliance with BS 5733) which is accessible without moving the appliance.

#### Disposing of the plug:

Ensure that before disposing of the plug itself, you make the pins unusable so that it cannot be accidentally inserted into a socket.

Instructions for connecting cable to an alternative plug: Important: the wires in the mains lead are coloured in accordance with the following code:

<b>Green &amp; Yellow</b>	<b>Earth</b>
<b>Blue</b>	<b>Neutral</b>
<b>Brown</b>	<b>Live</b>

As the colours of the wires in the lead may not correspond with the coloured markings identifying the terminals in your plug, proceed as follows:

Connect Green & Yellow wire to terminal marked **E** or  $\perp$  or coloured Green or Green & Yellow.

Connect Brown wire to terminal marked **L** or coloured Red.

Connect Blue wire to terminal marked **N** or coloured Black.

If a 13 amp plug (BS 1363) is used it must be fitted with a 13 amp fuse, either in the plug or adaptor or at the distribution board.

If you are in any doubt the electrical supply to your machine, consult a qualified electrician before use.

How to connect an alternative plug:

The wires in this mains lead are coloured in accordance with the following code:

<b>BLUE</b>	<b>NEUTRAL (N)</b>
<b>BROWN</b>	<b>LIVE (L)</b>
<b>GREEN &amp; YELLOW</b>	<b>EARTH (E)</b>

*Disposing of the appliance:*

When disposing of the appliance please remove the plug by cutting the mains cable as close as possible to the plug body and dispose of it as described above.

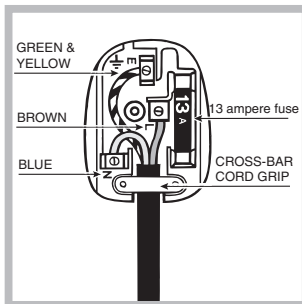

! The washer dryer should not be installed in an outdoor environment, not even when the area is sheltered, because it may be very dangerous to leave it exposed to rain and thunderstorms.



! When the washer dryer is installed, the mains socket must be within easy reach.

! Do not use extensions or multiple sockets.

! The power supply cable must never be bent or dangerously compressed.

! The power supply cable must only be replaced by an authorised serviceman.

Warning! The company denies all liability if and when these norms are not respected.

Technical data	
<b>Model</b>	AQM8L 29 I
<b>Dimensions</b>	width 59.5 cm height 85 cm depth 64,5 cm
<b>Capacity</b>	from 1 to 8 kg for wash programme from 1 to 6 kg for the drying programme
<b>Electrical connections</b>	please refer to the technical data plate fixed to the machine
<b>Water connections</b>	maximum pressure 1 MPa (10 bar) minimum pressure 0.05 MPa (0.5 bar) drum capacity 62 litres
<b>Spin speed</b>	up to 1200 rotations per minute
<b>Energy rated programmes according to regulation EN 50229</b>	programme  ; temperature 60°C; using a load of 8 kg. <b>Drying:</b> first drying cycle performed with a 2 kg load, by selecting the drying level "Iron dry"; second drying cycle performed with a 6 kg load, by selecting the maximum drying level "Cupboard Dry".
	This appliance conforms to the following EC Directives: - 89/336/EEC dated 03/05/89 (Electromagnetic Compatibility) and subsequent modifications - 2006/95/EC (Low Voltage) - 2002/96/EC

# Description of the machine

EN

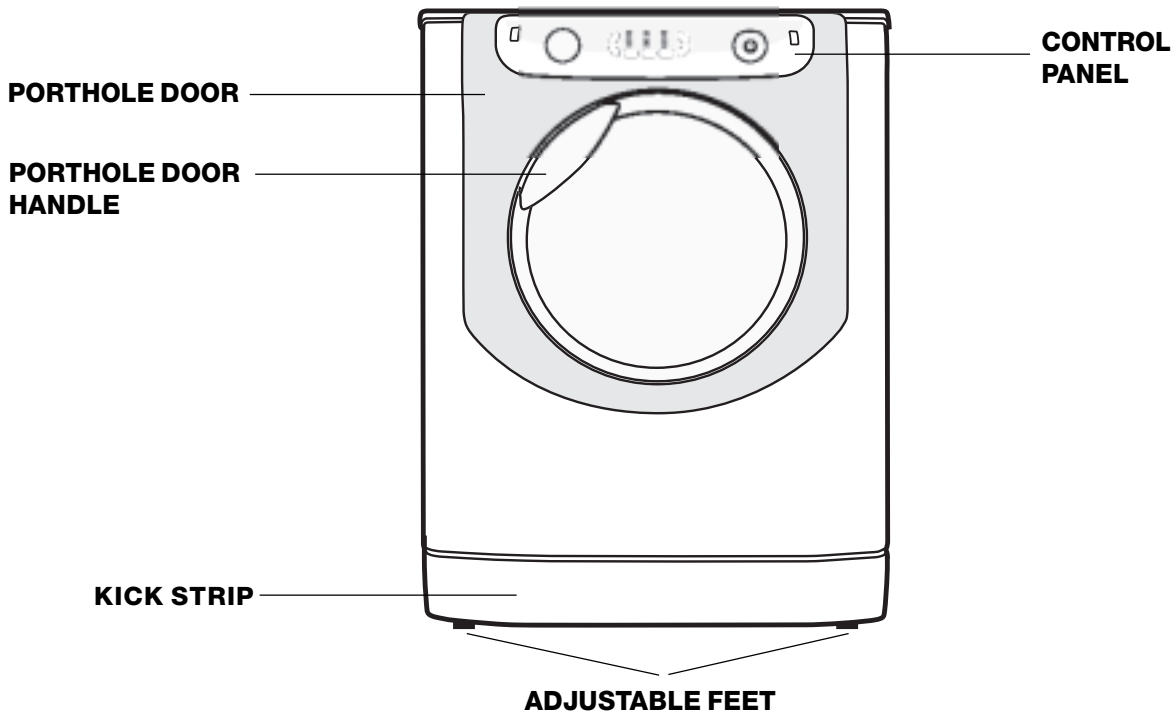

## PORTHOLE DOOR



Always use the handle to open the porthole door (see figure).

## DETERGENT DISPENSER DRAWER

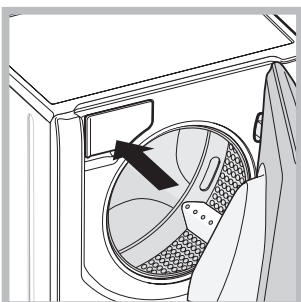

The detergent dispenser drawer is located inside the machine and can be accessed by opening the door. For more information on detergent measures, please refer to the chapter entitled "Detergents and laundry".

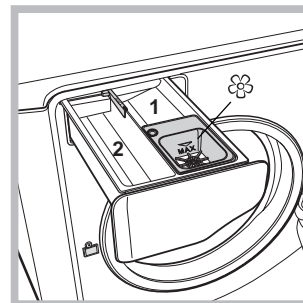

1. *pre-wash compartment*: use powder detergent.  
2. *main wash compartment*: use powder or liquid detergent. If using the latter type of detergent, we recommend it is poured into the drawer immediately before you start the washer dryer.

 *washing additives compartment*: for fabric softener or liquid additives. We recommend that the maximum level indicated by the grille is not exceeded, and that concentrated fabric softeners are diluted.

## Standby mode

This washer dryer, in compliance with new energy saving regulations, is fitted with an automatic standby system which is enabled after a few minutes if no activity is detected. Press the ON-OFF  button briefly and wait for the machine to start up again.

## Control panel

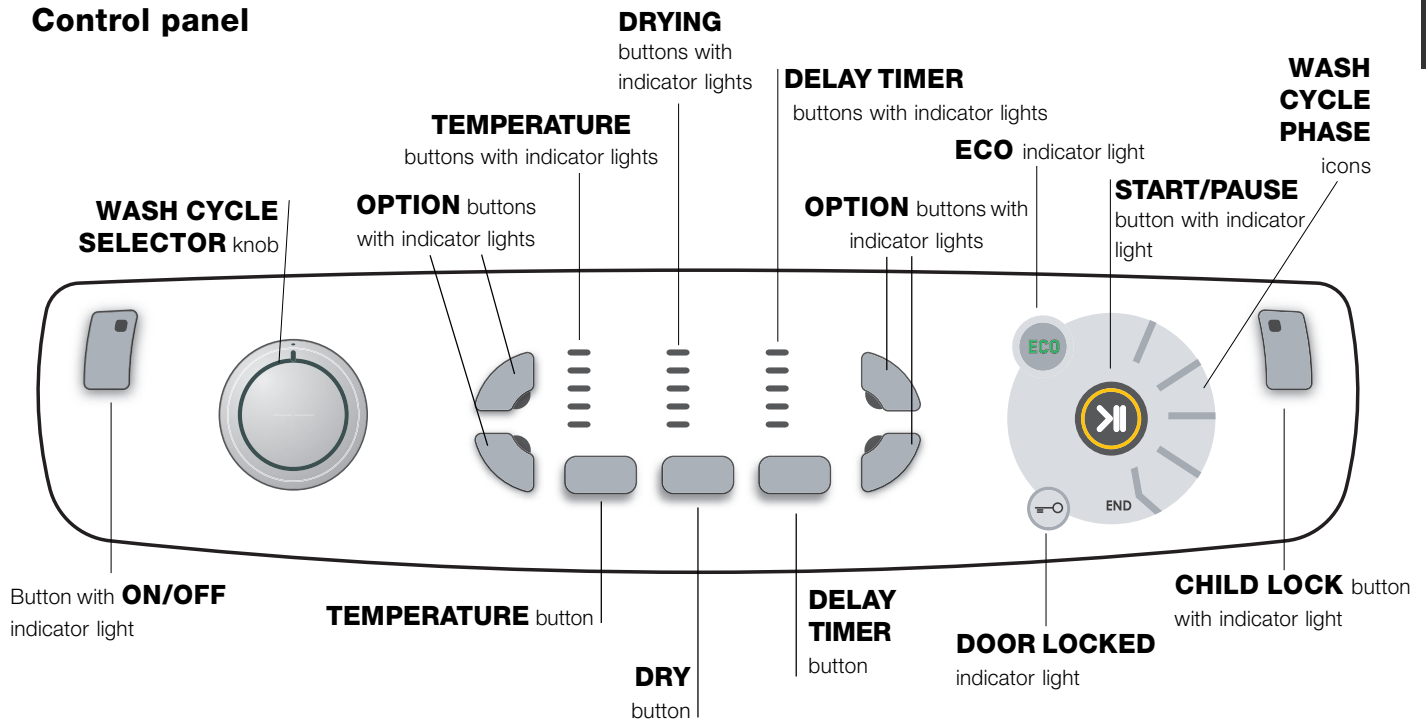

Button with **ON/OFF** indicator light: press this briefly to switch the machine on or off. The green indicator light indicates that the machine is switched on. To switch off the washer dryer during the wash cycle, press and hold the button for approximately 3 seconds; if the button is pressed briefly or accidentally the machine will not switch off. If the machine is switched off during a wash cycle, this wash cycle will be cancelled.

**WASH CYCLE SELECTOR** knob: may be turned in either direction. To select the most suitable wash cycle, please refer to the “Table of wash cycles”. The knob will not move during the wash cycle.

**TEMPERATURE** button: press to modify or exclude the temperature setting; the value will be identified by the indicator lights above it (see “Running a wash cycle”).

**DRY** button: press to decrease or exclude drying; the selected drying level or time will be identified by the indicator lights above it (see “How to run a wash cycle or a drying cycle”).

**DELAY TIMER** button: press to set a DELAY TIMER for the selected wash cycle; the set delay time will appear on the display above (see “Running a wash cycle”).

**OPTION** buttons with indicator lights: press to select the available options. The indicator light corresponding to the selected option will remain lit (see “Running a wash cycle”).

**WASH CYCLE PHASE** icons: these illuminate to indicate the progress of the wash cycle (Wash – Rinse – Spin/Drain – Drain ). The text **END** lights up when the cycle is complete.

**START/PAUSE** button with indicator light: when the green indicator light flashes slowly, press the button to start a wash cycle. Once the cycle has begun the indicator light will remain lit in a fixed manner. To pause the wash cycle, press the button again; the indicator light will flash in an orange colour. If the “Door locked” indicator light is switched off, the door may be opened. To start the wash cycle from the point at which it was interrupted, press the button again.

**DOOR LOCKED** indicator light: indicates that the porthole door is locked. To open the door, pause the wash cycle (see “Running a wash cycle”).



**CHILD LOCK** button with indicator light: to activate or deactivate the CHILD LOCK, press and hold the button for approximately 2 seconds. when the indicator light is illuminated, the control panel is locked. This means it is possible to prevent wash cycles from being modified accidentally, especially where there are children in the home.

**ECO** indicator light: the **ECO** icon lights up when, after altering the washing parameters, an energy saving of at least 10% is made. Furthermore, before the machine enters “Standby” mode, the icon will light up for a few seconds; when the machine is switched off the estimated energy saving will be around the 80% mark.

# Running a wash cycle

EN

**WARNING:** before you use the washer dryer for the first time, run a wash cycle with detergent and no laundry, using the 90° cottons cycle without pre-wash.

- 1. SWITCH THE MACHINE ON.** Press the  button. All the indicator lights will illuminate for 1 second; the indicator light corresponding to the  button will then remain lit in a fixed manner and the START/PAUSE indicator light will flash slowly.
- 2. LOAD THE LAUNDRY.** Open the porthole door. Load the laundry, making sure you do not exceed the maximum load value indicated in the table of wash cycles on the following page.
- 3. MEASURE OUT THE DETERGENT.** Pull out the detergent dispenser drawer and pour the detergent into the relevant compartments as described in "Description of the machine".
- 4. CLOSE THE PORTHOLE DOOR.**
- 5. SELECT THE PROGRAMME.** Turn the WASH CYCLE SELECTOR KNOB right or left, until you have selected the desired wash cycle. A temperature and spin speed is set for each wash cycle; these may be adjusted.
- 6. CUSTOMISE THE WASH CYCLE.** Use the relevant buttons on the control panel:

## **Modify the temperature.**

The machine automatically displays the maximum temperature values set for the selected cycle, or the most recently-used settings if they are compatible with the selected cycle. The temperature can be decreased by pressing the  button, until the cold wash "❄️" setting is reached. If these buttons are pressed again, the maximum values are restored.

! Exception: if the "Cotton" programme is selected, the temperature can be increased up to a value of 90°C.

## **Setting the drying cycle**

The first time the button is pressed, the machine will automatically select the maximum drying cycle which is compatible with the selected wash cycle. Subsequent presses will decrease the drying level and then the drying time, until the cycle is excluded completely (). If these buttons are pressed again, the maximum values are restored.

Two types of drying may be selected:

- A** - Based on a set time period: between **60'** and **180'**.
- B** - Based on the how damp the clothes are once they have been dried:

**Iron dry:** slightly damp clothes, easy to iron.

**Cupboard dry:** suitable for laundry which can be put back in a cupboard without being ironed.

If your laundry load to be washed and dried is much greater than the maximum stated load (see below table), perform the wash cycle, and when the cycle is complete, divide the garments into groups and put some of them back in the drum. At this point, follow the instructions provided for a "Drying only" cycle. Repeat this procedure for the remainder of the load.

**N.B:** a cooling-down period is always added to the end of each drying cycle.

## **Drying only**



Use the cycle selector knob to select a drying cycle () in accordance with the type of fabric. The desired drying level or time may also be set using the DRYING button .

Table of drying times (guideline values)

Fabric type	Load type	Max. load (kg)	Cupboard	Iron
Cotton	Clothing of different sizes, Terry towels	6	200	150
Synthetics	Sheets, Shirts, Pyjamas, socks, etc.	3,5	140	120
Wool	Knitwear, Pullovers, etc.	1,5	160	130

The information contained in the table is purely indicative.

## **Set a DELAY TIMER.**

To set the "delay timer" option for the program you have selected, press the button until the indicator light for the desired delay time is illuminated.

The sixth time the button is pressed, the function will be disabled.

**N.B.:** once the START/PAUSE button is pressed the "delay timer" indicator light will flash (the time delay value may only be changed by decreasing the time).

## **Modify the cycle settings.**



Press the OPTION buttons to customise the wash cycle in accordance with your own requirements.

- Press the button to activate the option; the corresponding indicator light will switch on.
- Press the button again to disable the option; the indicator light will switch off.

! If the selected option is not compatible with the selected wash cycle, this incompatibility will be signalled by the flashing of the indicator light and a sound alert (3 beeps); the option will not be activated.



! If the selected option is not compatible with another option that has been selected previously, the indicator light corresponding to the first option selected will flash and only the second option will be activated; the indicator light corresponding to the button will remain lit in a constant manner.

7. **START THE PROGRAMME.** Press the START/PAUSE button. The corresponding indicator light remains lit in a fixed manner and the porthole door locks (the  DOOR LOCKED indicator light illuminates). The icons corresponding to the wash cycle phases will light up during the cycle to indicate which phase is currently in progress. To change a wash cycle once it has already started, pause the washer dryer by pressing the START/PAUSE button; then select the desired cycle and press the START/PAUSE button again. To open the door during a wash cycle, press the START/PAUSE button; if the DOOR LOCKED  indicator light is switched off you may open the door. Press the START/PAUSE button again to restart the wash cycle from the point at which it was interrupted.

8. **THE END OF THE WASH CYCLE.** This is indicated by the illuminated text **END**. The porthole door may be opened immediately. If the START/PAUSE indicator light is flashing, press the button to end the cycle. Open the door, unload the laundry and switch off the machine.

! If you wish to cancel a cycle which has already begun, press and hold the  button until the cycle stops and the machine switches off.

# Wash cycles and options

EN

**Table of wash cycles**

Icon	Description of the wash cycle	Max. temp. (°C)	Max. speed (rpm)	Drying	Detergent and additives			Max. load (kg)	Cycle duration
					Pre-wash	Wash	Fabric softener		
<b>Cottons wash cycles</b>									
	<b>Cotton with pre-wash</b> (Add detergent to the relevant compartment).	90°	1200	●	●	●	●	8	184
	<b>Cotton (1):</b> heavily soiled whites and resistant colours.	60° (Max. 90°)	1200	●	-	●	●	8	160
	<b>Cotton (2):</b> heavily soiled whites and delicate colours.	40°	1200	●	-	●	●	8	147
	Coloured <b>Cotton (3)</b>	40°	1200	●	-	●	●	8	96
<b>Special wash cycles</b>									
	* <b>Steam Refresh</b> (see next page)	-	-	-	-	-	-	1,5	20
	<b>Baby:</b> heavily soiled delicate colours	40°	800	●	-	●	●	2	118
	<b>Mix 30<sup>®</sup>:</b> to refresh lightly soiled garments quickly (not suitable for wool, silk and clothes which require washing by hand)	30°	800	●	-	●	●	3,5	30
	Durable <b>Synthetics</b>	60°	800	●	-	●	●	4	85
	<b>Delicates:</b> for garments in silk and viscose, lingerie.	30°	0	-	-	●	●	2	55
	<b>Wool:</b> for wool, cashmere, etc.	40°	800	●	-	●	●	2	55
<b>Drying Cycles</b>									
	<b>Wash &amp; Dry</b>	30°	1200	●	-	●	●	1	60
	<b>Cotton dry</b>	-	-	●	-	-	-	6	-
	<b>Synthetics dry</b>	-	-	●	-	-	-	3,5	-
	<b>Wool dry</b>	-	-	●	-	-	-	1,5	-
<b>Partial cycles</b>									
	Rinse	-	1200	●	-	-	●	8	36
	Spin	-	1200	●	-	-	-	8	16
	Drain	-	0	-	-	-	-	8	2

For all Test Institutes:

- 1) Test wash cycle in compliance with regulation EN 50229: set wash cycle with a temperature of 60°C.
- 2) Long wash cycle for cottons: set wash cycle with a temperature of 40°C.
- 3) Short wash cycle for cottons: set wash cycle with a temperature of 40°C.

## Wash options

### **Steam Hygiene**

This option enhances washing performance by generating steam during the wash cycle that eliminates any bacteria from fibres while treating them at the same time. Place the laundry in the drum, choose a compatible programme and select option "".

! The steam generated during washer dryer operation may cause the porthole door to become hazy.

! It cannot be used in conjunction with (90°C), (1), (2), (3), , , , , , , , , , , .

### **Slow Spin**

Press this button to reduce the spin speed.

! It cannot be used in conjunction with (1), (2), (3), , , , , , , , , , , .

### **Eco Option**

The Eco Wash function saves energy by not heating the water used to wash your laundry – an advantage both to the environment and to your energy bill. Instead, intensified wash action and water optimisation ensure great wash results in the same average time of a standard cycle.

For the best washing results we recommend the usage of a liquid detergent.

! It cannot be used in conjunction with , , , , , , , , , , , .

### **Time Saver**

If you select this option, the wash cycle duration will be reduced by 30%-50%, depending on the selected cycle, thereby guaranteeing simultaneous water and energy saving. Use this cycle for lightly soiled garments.

! It cannot be used in conjunction with (1), (2), (3), , , , , , , , , , , .

## Detergent

The type and quantity of detergent required depend on the type of fabric you are washing (cotton, wool, silk, etc.), as well as its colour, the washing temperature, the level of soiling and the hardness of the water in the area. Measuring out the detergent carefully will avoid wastage and help to protect the environment: although they are biodegradable, detergents still contain ingredients which alter the balance of nature.

We recommend the following:

- use powder detergents for white cotton garments and pre-washing.
- use liquid detergents for delicate cotton garments and for all low-temperature wash cycles.
- use gentle liquid detergents for wool and silk garments.

The detergent should be poured into the relevant compartment - or the dispenser placed directly inside the drum - before the wash cycle begins. In the latter case, it will not be possible to select the Cottons with pre-wash cycle.

! Do not use hand washing detergents because these create too much foam.

## Preparing the laundry

- Shake out the garments before loading them into the machine.
- Divide the laundry according fabric type (symbol on the washing instruction label) and colour, making sure you separate the coloured garments from the white ones;
- Empty all pockets and check the buttons;
- Do not exceed the values listed in the "Table of wash cycles", which refer to the weight of the laundry when dry.

### How much does your laundry weigh?

1 sheet	400-500 g
1 pillowcase	150-200 g
1 tablecloth	400-500 g
1 bathrobe	900-1200 g
1 towel	150-250 g
1 pair of jeans	400-500 g
1 shirt	150-200 g

## Washing recommendations

### \* Steam Refresh

This programme refreshes garments by removing bad odours and relaxing the fibres (1.5 kg, roughly 3 items). Insert dry items only (that are not dirty) and select programme "👚". The garments will be damp once the cycle is completed, so we recommend hanging them to dry. The "👚" programme makes ironing easier. Moreover, with the "Steam Perfume" laundry balls, your favourite perfume can be added to your laundry. Place a few drops of perfume on the sponge contained inside the laundry ball, close it and insert it into the drum together with the laundry. Then launch the specific programme "👚". At the end of the cycle, garments will be relaxed and fragrant.

! Not recommended for **wool** or **silk** garments.

! Do not add too much perfume to the sponge in order to avoid it dripping.

! Do not add softeners or detergents.

**Baby:** use the special "Baby" 👶 wash cycle to remove the soiling typically caused by babies, while removing all traces of detergent from nappies in order to prevent the delicate skin of babies from suffering allergic reactions. The cycle has been designed to reduce the amount of bacteria by using a greater quantity of water and optimising the effect of special disinfecting additives added to the detergent. At the end of the wash cycle, the machine will slowly rotate the drum; to end the cycle press the START/PAUSE button.

**Silk:** use the special "Silk" 🧶 wash cycle to wash all silk garments. We recommend the use of special detergent which has been designed to wash delicate clothes.

**Curtains:** use the "Silk" 🧶 wash cycle. Fold curtains and place them in a pillow case or mesh bag.

**Wool:** Hotpoint is the only washer dryer brand to have been awarded the prestigious Woolmark Platinum Care endorsement (M.0508) by the Woolmark Company, which means that all woollen garments may be washed in the washer dryer, even those which state "hand wash only" 🧺 on the label. The "Wool" wash cycle can be used to wash all woollen garments in the washer dryer while guaranteeing optimum performance.

**Wash & Dry** 🧺 was designed to wash and dry lightly soiled garments quickly. This cycle may be used to wash and dry a laundry load of up to 1 kg in just 60 minutes. To achieve optimum results, use liquid detergent and pre-treat cuffs, collars and stains.

## Load balancing system

Before every spin cycle, to avoid excessive vibrations before every spin and to distribute the load in a uniform manner, the drum rotates continuously at a speed which is slightly greater than the washing rotation speed. If, after several attempts, the load is not balanced correctly, the machine spins at a reduced spin speed. If the load is excessively unbalanced, the washer dryer performs the distribution process instead of spinning. To encourage improved load distribution and balance, we recommend small and large garments are mixed in the load.

# Precautions and tips

EN

! The machine was designed and constructed in accordance with international safety regulations. The following information is provided for safety reasons and must therefore be read carefully.

## General safety

- This appliance was designed for domestic use only.
- the machine must only be used by adults, in accordance with the instructions given in this manual.
- Do not touch the machine when barefoot or with wet or damp hands or feet.
- Do not pull on the power supply cable when unplugging the appliance from the electricity socket. Hold the plug and pull.
- Do not touch the drained water as it may reach extremely high temperatures.
- Never force the porthole door. This could damage the safety lock mechanism designed to prevent accidental opening.
- If the appliance breaks down, do not under any circumstances access the internal mechanisms in an attempt to repair it yourself.
- Always keep children well away from the appliance while it is operating.
- If it must be moved, proceed with the help of two or three people and handle it with the utmost care. Never try to do this alone, because the appliance is very heavy.
- Before loading laundry into the washer dryer, make sure the drum is empty.
- During the drying phase, the door tends to get quite hot.
- Do not use the appliance to dry clothes that have been washed with flammable solvents (e.g. trichlorethylene).
- Do not use the appliance to dry foam rubber or similar elastomers.
- Make sure that the water tap is turned on during the drying cycles.

## Disposal

- Disposing of the packaging materials: observe local regulations so that the packaging may be re-used.
- The European Directive 2002/96/EC relating to Waste Electrical and Electronic Equipment (WEEE) states that household appliances should not be disposed of using the normal solid urban waste cycle. Exhausted appliances should be collected separately in order to optimise the cost of re-using and recycling the materials inside the machine, while preventing potential damage to the atmosphere and to public

health. The crossed-out dustbin is marked on all products to remind the owner of their obligations regarding separated waste collection.

For more information relating to the correct disposal of household appliances, owners should contact their local authorities or appliance dealer.

## Opening the porthole door manually

In the event that it is not possible to open the porthole door due to a powercut, and if you wish to remove the laundry, proceed as follows:

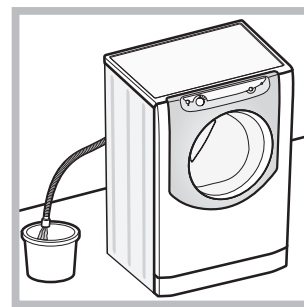

1. remove the plug from the electrical socket.
2. make sure the water level inside the machine is lower than the door opening; if it is not, remove excess water using the drain hose, collecting it in a bucket as indicated in the *figure*.

3. remove the cover panel on the lower front part of the washer dryer (see *overleaf*).

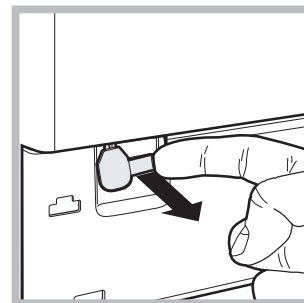

4. pull outwards using the tab as indicated in the figure, until the plastic tie-rod is freed from its stop position; pull downwards until you hear a “click”, which indicates that the door is now unlocked.

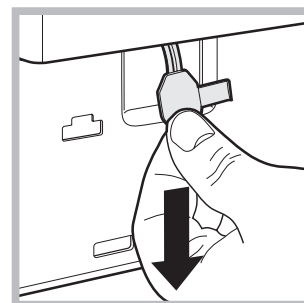

5. open the door; if this is still not possible repeat the procedure.

6. reposition the panel, making sure the hooks are securely in place before you push it onto the appliance.

## Cutting off the water and electricity supplies

- Turn off the water tap after every wash cycle. This will limit wear on the hydraulic system in the machine and help to prevent leaks.
- Unplug the appliance when cleaning it and during all maintenance work.

## Cleaning the machine

The outer parts and rubber components of the appliance can be cleaned using a soft cloth soaked in lukewarm soapy water. Do not use solvents or abrasives.

## Cleaning the detergent dispenser drawer

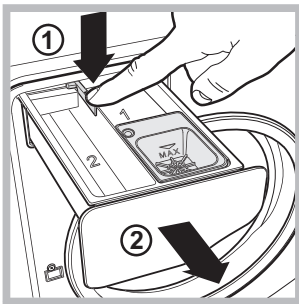

To remove the drawer, press lever (1) and pull the drawer outwards (2) (see figure). Wash it under running water; this procedure should be repeated frequently.

## Caring for your appliance drum

- Always leave the door ajar to prevent unpleasant odours from forming.

## Cleaning the pump

The washer dryer is fitted with a self-cleaning pump which does not require any maintenance. Sometimes, small items (such as coins or buttons) may fall into the protective pre-chamber at the base of the pump.

**!** Make sure the wash cycle has finished and unplug the appliance.

To access the pre-chamber:

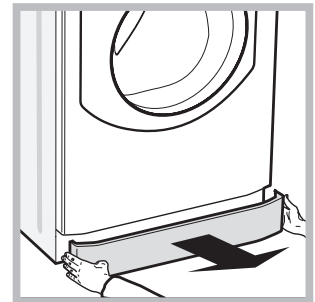
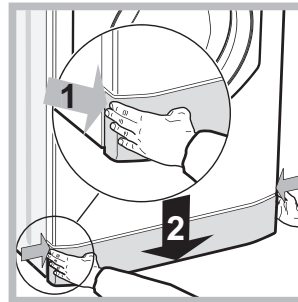

1. take off the cover panel on the front of the machine by first pressing it in the centre and then pushing downwards on both sides until you can remove it (see figures);

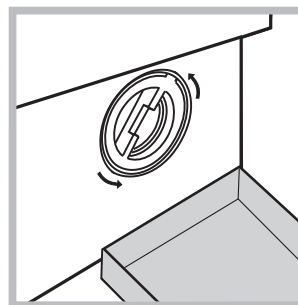

2. position a container so that it will collect the water which flows out (approximately 1.5 l) (see figure);  
3. unscrew the lid by rotating it in an anti-clockwise direction (see figure);

4. clean the inside thoroughly;  
5. screw the lid back on;  
6. reposition the panel, making sure the hooks are securely in place before you push it onto the appliance.

## Checking the water inlet hose

Check the inlet hose at least once a year. If there are any cracks, it should be replaced immediately: during the wash cycles, water pressure is very strong and a cracked hose could easily split open.

# Trouble shooting

EN

Your washer dryer could occasionally fail to work. Before contacting the Technical Assistance Centre (see "Assistance"), make sure that the problem cannot be not solved easily using the following list.

## Problem:

## Possible causes / Solutions:

**The washer dryer does not switch on.**

- The appliance is not plugged into the socket fully, or not enough to make contact.
- There is no power in the house.



**The wash cycle does not start.**

- The door is not closed properly.
- The START/PAUSE button has not been pressed.
- The water tap has not been opened.
- A DELAY TIMER has been set.

**The washer dryer does not fill with water.**

- The water inlet hose is not connected to the tap.
- The hose is bent.
- The water tap has not been opened.
- There is no water supply in the house.
- The pressure is too low.
- The START/PAUSE button has not been pressed.

**The washer dryer door remains locked.**

- If you have selected the "Baby  cycle option, when the wash cycle has finished the machine will slowly rotate the drum; to end the cycle press the START/PAUSE button. If you have selected the "Silk  wash cycle, the machine will end the cycle while the laundry is soaking; to drain the water so that the laundry may be removed, press the START/PAUSE button.

**The machine continuously fills with water and drains.**

- The drain hose is not fitted at a height between 65 and 100 cm from the floor (see "Installation").
- The free end of the hose is under water (see "Installation").
- If the dwelling is on one of the upper floors of a building, there may be problems relating to water drainage, causing the washer dryer to fill with water and drain continuously. Special anti-draining valves are available in shops and help to prevent this inconvenience.
- The wall drainage system is not fitted with a breather pipe.

**The washer dryer does not drain or spin.**

- The wash cycle does not include draining: Some wash cycles require the drain phase to be started manually (see "Wash cycles and options").
- The drain hose is bent (see "Installation").
- The drainage duct is clogged.

**The machine vibrates a lot during the spin cycle.**

- The drum was not unlocked correctly during installation (see "Installation").
- The machine is not level (see "Installation").
- The machine is trapped between cabinets and walls (see "Installation").
- The load is unbalanced (see "Detergents and laundry").

**The washer dryer leaks.**

- The water inlet hose is not screwed on properly (see "Installation").
- The detergent dispenser is blocked (to clean it, see "Care and maintenance").
- The drain hose is not fixed in place properly (see "Installation").

**The icons corresponding to the "Phase in progress" flash rapidly at the same time as the ON/OFF indicator light.**

- Switch off the machine and unplug it, wait for approximately 1 minute and then switch it back on again. If the problem persists, contact the Technical Assistance Service.

**There is too much foam.**

- The detergent is not suitable for machine washing (it should display the text "for washer dryers" or "hand and machine wash", or the like).
- Too much detergent was used.

**The washer dryer door remains locked.**

- Perform the manual unlocking procedure (see "Precautions and tips").

**The washer-dryer does not dry.**

- The appliance is not plugged into the socket, or not enough to make contact.
- There has been a power failure.
- The appliance door is not shut properly.
- A DELAY TIMER has been set.
- DRYING is in the  position.

## Guarantee

### 12 Months Parts and Labour Guarantee

Your appliance has the benefit of our manufacturer's guarantee, which covers the cost of breakdown repairs for twelve months from the date of purchase.

This gives you the reassurance that if, within that time, your appliance is proven to be defective because of either workmanship or materials, we will, at our discretion, either repair or replace the appliance at no cost to you.

This guarantee is subject to the following conditions:

- The appliance has been installed and operated correctly and in accordance with our operating and maintenance instructions.
- The appliance is used only on the electricity or gas supply printed on the rating plate.
- The appliance has been used for normal domestic purposes only.
- The appliance has not been altered, serviced, maintained, dismantled, or otherwise interfered with by any person not authorised by us.
- Any repair work must be undertaken by us or our appointed agent.
- Any parts removed during repair work or any appliance that is replaced become our property.
- The appliance is used in the United Kingdom or Republic of Ireland.

The guarantee **does not cover:**

- Damage resulting from transportation, improper use, neglect or interference or as a result of improper installation.
- Replacement of any consumable item or accessory . These include but are not limited to: plugs, cables, batteries, light bulbs, fluorescent tubes and starters, covers and filters.
- Replacement of any removable parts made of glass or plastic.

**THIS GUARANTEE WILL NOT APPLY IF THE APPLIANCE HAS BEEN USED IN COMMERCIAL OR NON-DOMESTIC PREMISES.**

### 5 Year Parts Guarantee

Hotpoint also offers you a free 5 year parts guarantee. This additional guarantee is conditional on you registering your appliance with us and the parts being fitted by one of our authorised engineers.

There will be a charge for our engineer's time. To activate the extra parts warranty on your appliance, simply call our registration line on **08448 24 24 24 (ROI 01 230 0800)**.

### Extended Guarantees

We offer a selection of repair protection plans that enable you to fully cover yourself against the expense of repair bills for the life of your policy. To find the ideal plan for you please call our advice line on **08448 226 226 (Republic of Ireland 01 230 0233)**.

### Free Helpdesk Service

We have a dedicated team who can provide free advice and assistance with your appliance if you experience any technical difficulties within the first 90 days of ownership. Simply call our Hotpoint Service Hotline on **08448 224 224 (Republic of Ireland 0818 313 413)** for telephone assistance, or, where necessary, to arrange for an engineer to call. If we cannot resolve the technical problem we will replace your machine or, if you prefer, give you your money back.

## After Sales Service

No one is better placed to care for your Hotpoint appliance during the course of its working life than us - the manufacturer.

### Essential Contact Information

#### Hotpoint Service

We are the largest service team in Europe offering you access to 400 skilled telephone advisors and 1000 fully qualified engineers on call to ensure you receive fast, reliable, local service.

**UK: 08448 224 224**

**Republic of Ireland: 0818 313 413**

**[www.hotpointservice.co.uk](http://www.hotpointservice.co.uk)**

**Please note: Our advisors will require the following information:**

**Model number:**

**Serial number:**

#### Parts and Accessories

We supply a full range of genuine replacement parts as well as accessory products that protect and hygienically clean your appliance to keep it looking good and functioning efficiently throughout its life.

**UK: 08448 225 225**

**Republic of Ireland: 0818 313 413**

**[www.hotpointservice.co.uk](http://www.hotpointservice.co.uk)**

#### Appliance Registration

We want to give you additional benefits of Hotpoint ownership. To activate your free 5 year parts guarantee you must register your appliance with us.

**UK: 08448 24 24 24**

**Republic of Ireland: 01 230 0800**

**[www.hotpointservice.co.uk](http://www.hotpointservice.co.uk)**

**Indesit Company UK Ltd. Morley Way, Peterborough, PE2 9JB**

Indesit Company Unit 49 Airways Industrial Estate, Dublin 17



### Recycling & Disposal Information

As part of Hotpoint's continued commitment to helping the environment, Hotpoint reserves the right to use quality, recycled components to keep down customer costs and minimise material wastage.

Please dispose of packaging and old appliances carefully. To minimise the risk of injury to children, remove the door, plug and cut the mains cable off flush with the appliance. Dispose of these parts